

**GE 7** 230/CEE  
110/CEE

ETL-Nr. 458.740 Blatt 1

Stand 01-2022

status-date 01-2022

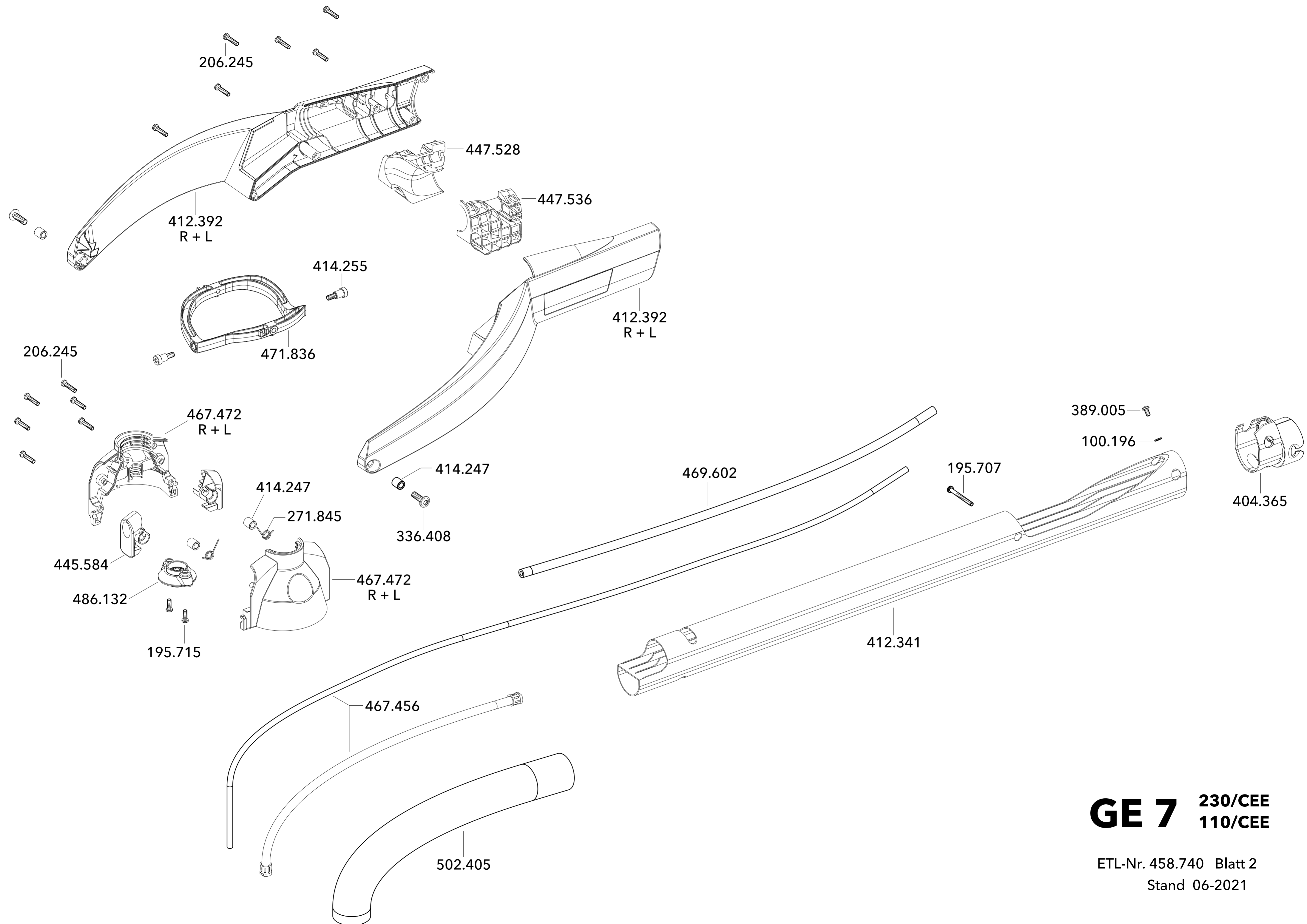

**GE 7** 230/CEE  
110/CEE

ETL-Nr. 458.740 Blatt 2  
Stand 06-2021

# MH-R D225

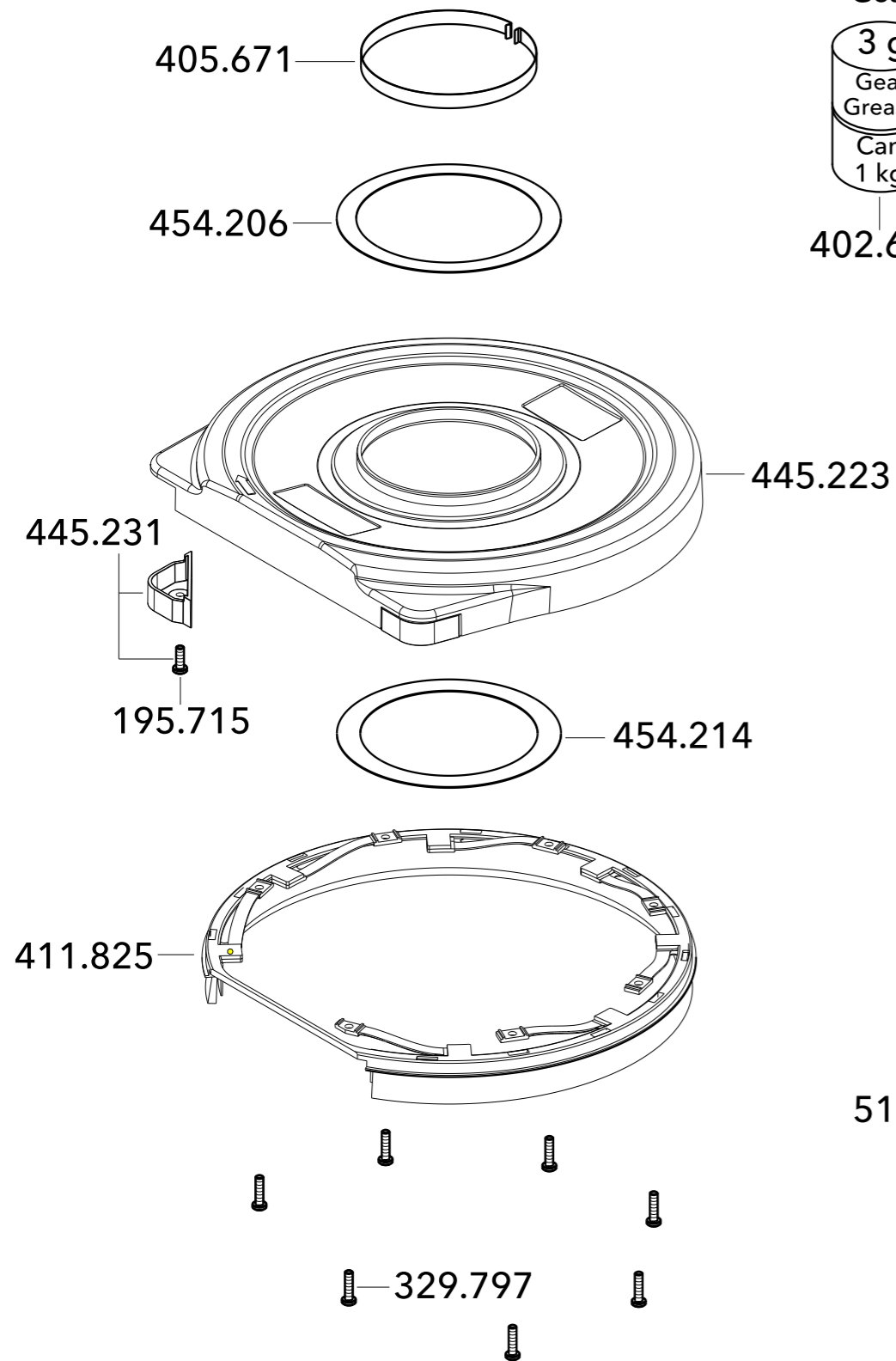

Planetary  
Gear  
3 g  
Gear  
Grease  
Can  
1 kg

402.648

Planeten-  
Getriebe  
3 g  
Getriebe  
Fett  
Dose  
1 kg

402.648

208.450

486.949

445.606

510.459

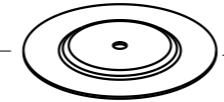
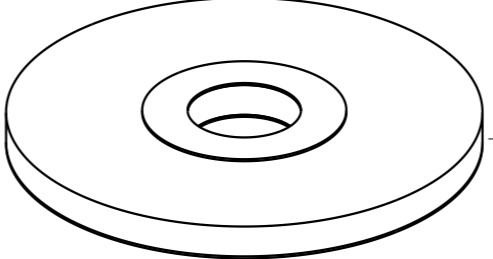
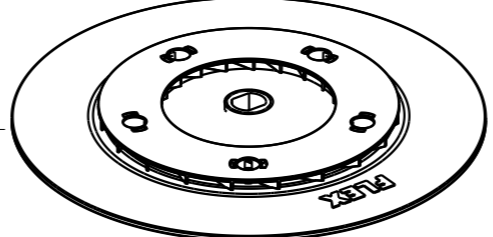
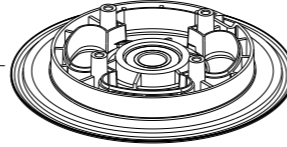
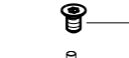
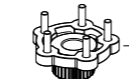
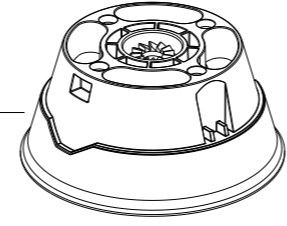
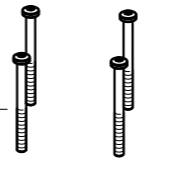

420.247

467.499

452.246

467.502

279.560

452.262

445.746

407.038

268.011

453.382

506.206

483.109

393.282

419.885

# MH-O D225

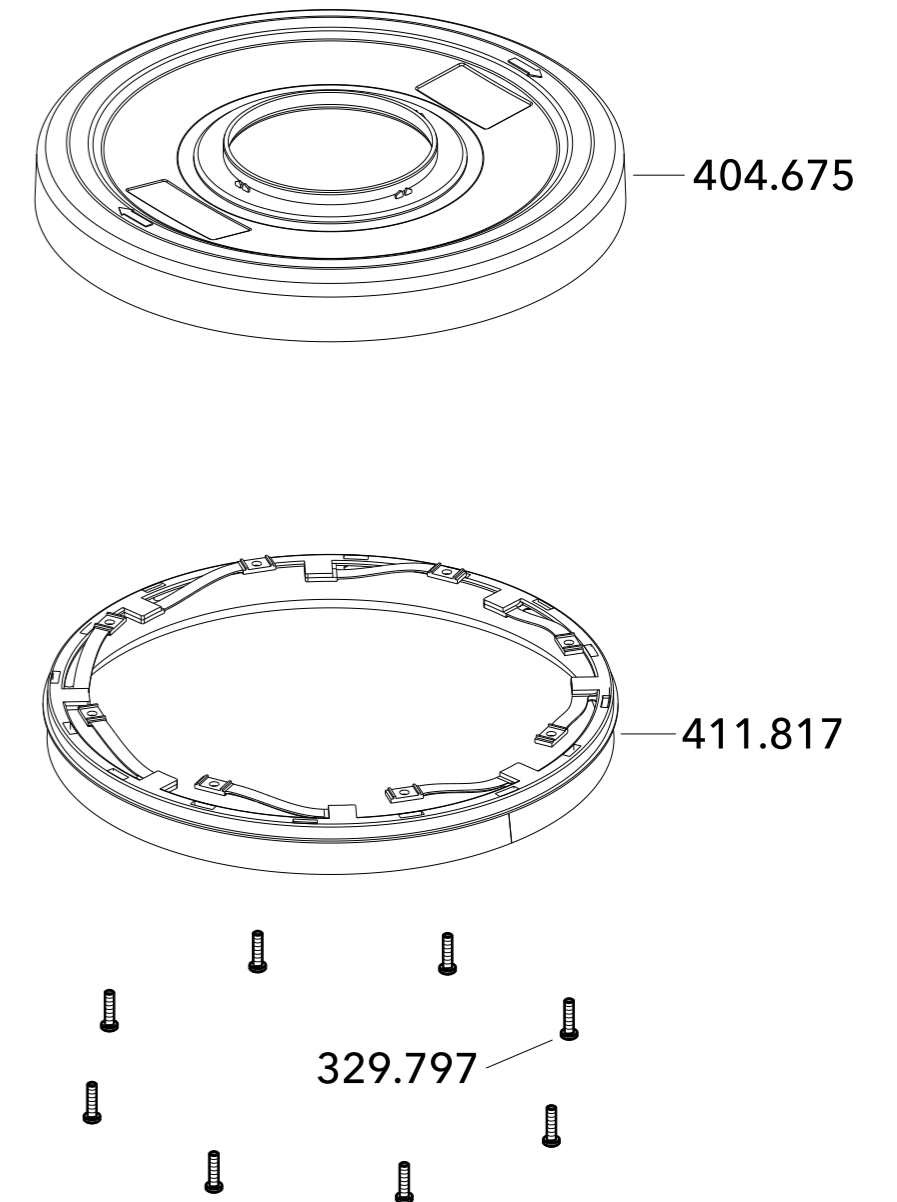

**GE 7** 230/CEE  
110/CEE

ETL-Nr. 458.740 Blatt 3

Stand 07-2021

# MH-T 290x290

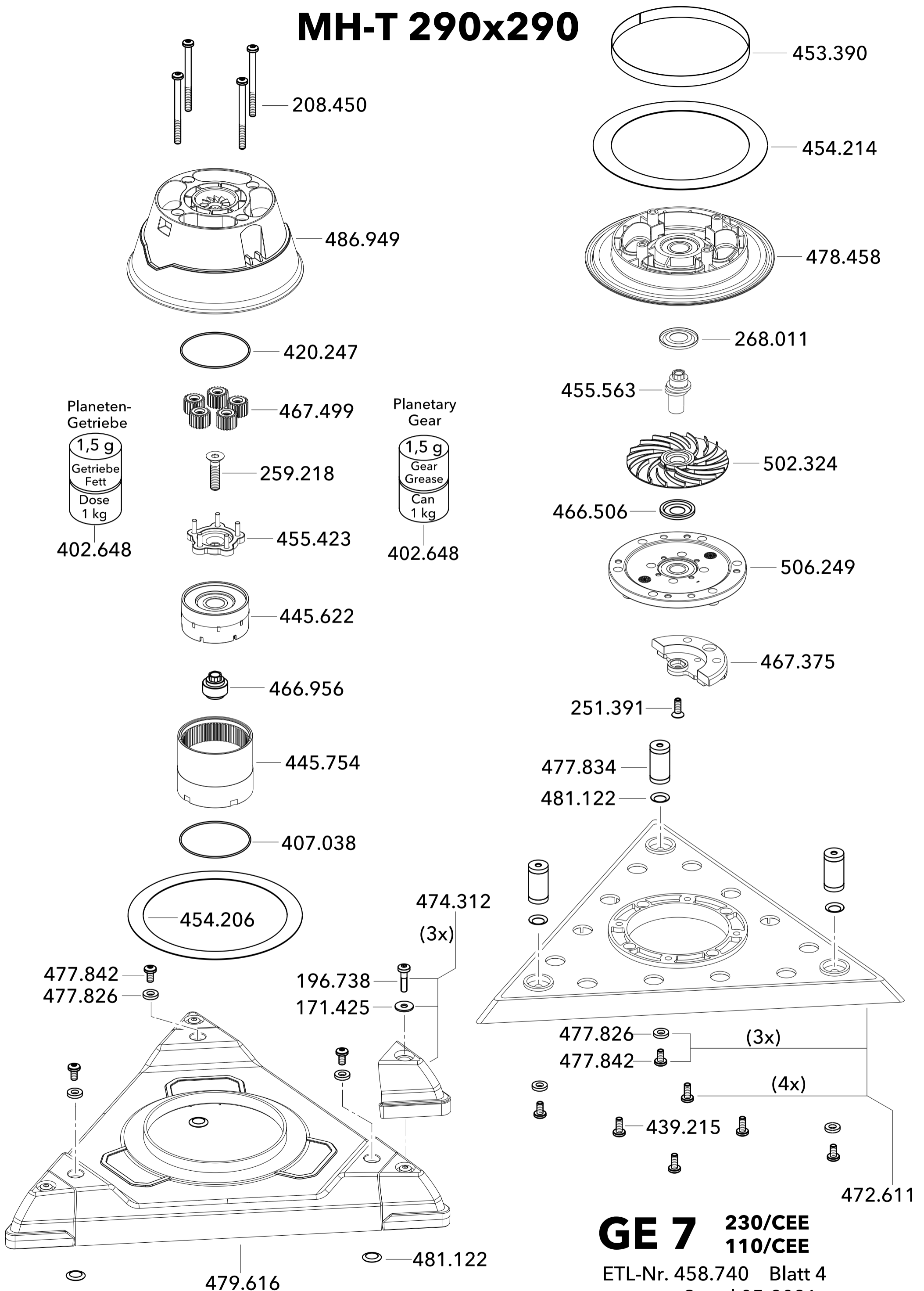

**GE 7 230/CEE**  
**110/CEE**

ETL-Nr. 458.740 Blatt 4

Stand 05-2021

status-date 05-2021

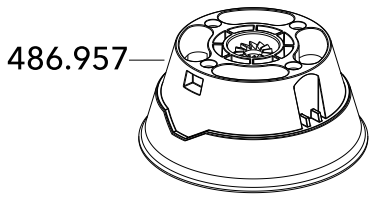
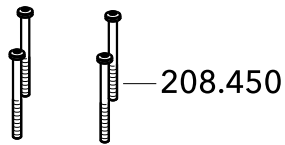

# MH-X D225

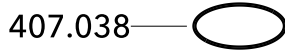
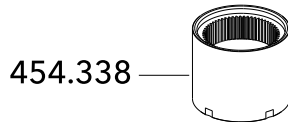
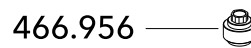
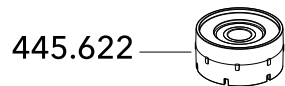
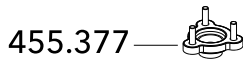
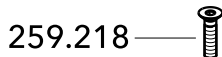
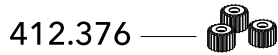
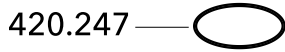

Planeten-  
Getriebe



402.648

Planetary  
Gear

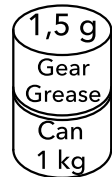

402.648

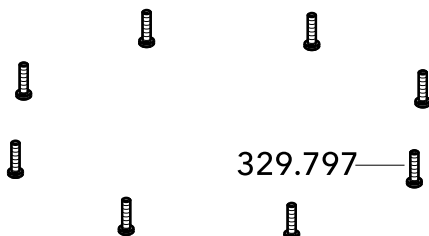
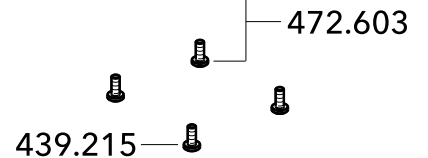
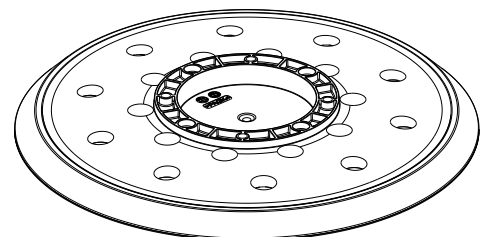
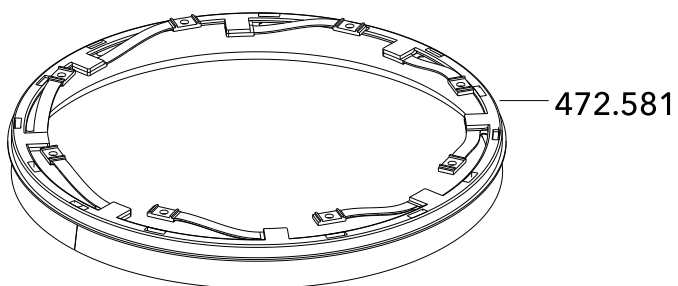
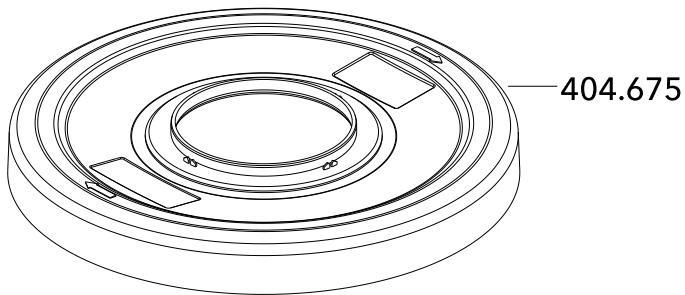
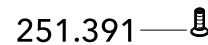
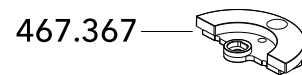
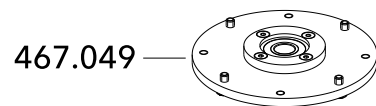
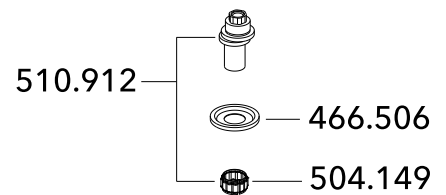
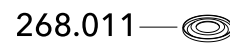
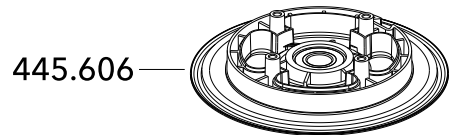

**GE 7** 230/CEE  
110/CEE

ETL-Nr. 458.740 Blatt 5  
Stand 02-2021